

Portails et Portillons

Version 21-03-2022

Informations générales :

- Les dimensions indiquées dans ce catalogue sont en millimètres.
- Les prix publics indiqués dans ce catalogue sont en euro hors taxes.
- En cas de livraison des frais de transport seront appliqués.
- Les profilés peuvent être coupés sur mesure. (Attention un supplément sera appliqué sur chaque coupe)

Services disponibles

- Laquage
- Anodisation
- Coupe
- Pliage
- Stockage
- ...

Conseils & Remarques







- Tous nos produits nécessitent un nettoyage régulier afin de maintenir un aspect visuel correct
- Dans des cas extrêmes l'aluminium peut avoir une dilatation importante (jusqu'à plusieurs millimètres par mètre)
- L'aluminium non traité en surface réagit au contact de l'air ambiant pour former de la corrosion pouvant détériorer l'esthétique du produit.
- L'édition de ce document rend toute autre documentation antérieure obsolète, nous nous réservons le droit de modifier ce document dans le cadre d'améliorations ou de nouveautés techniques

Contacts

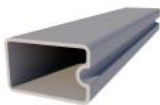
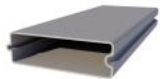
- Site web : www.dz-aluminium.fr
- Mail : contact@dzaluminium.fr
- Adresse : 4 rue de l'industrie, 67118 Geispolsheim
- Téléphone : +33 (0)3 88 30 68 85

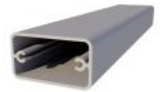





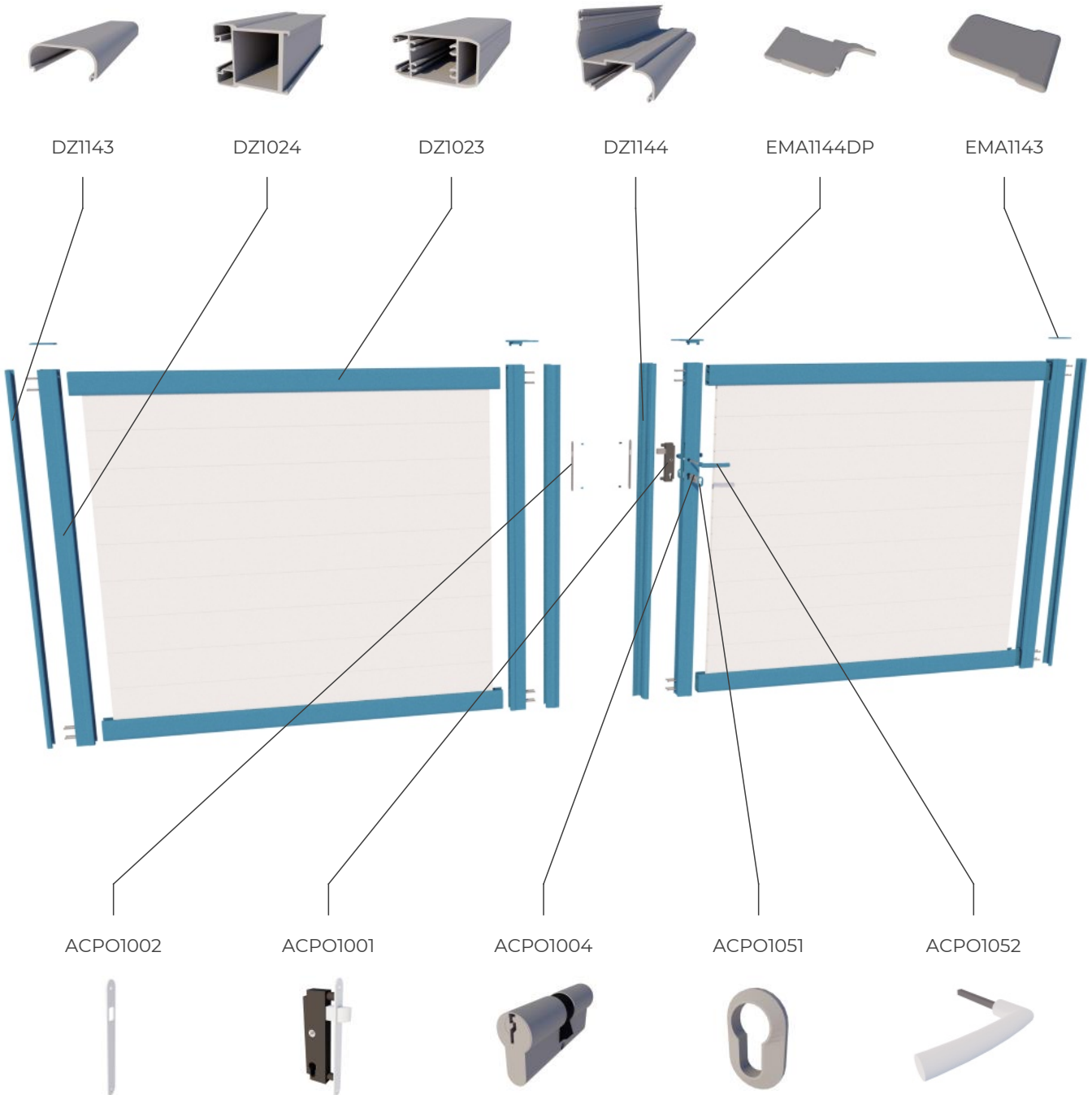



Consultez-nous sur :

contact@dzaluminium.fr

	Référence	Description	Longueur	Taille	Prix H.T.
	DZ3124	Lambris 40 x 25 mm	6 m	40 x 25 mm	10,23 €/m
	DZ3031	Lambris 80 x 25 mm	6 m	80 x 25 mm	14,11 €/m
	DZ5005	Lambris 160 x 25 mm	6 m	160 x 25 mm	36,78 €/m
	DZ5006	Lambris 240 x 25 mm	6 m	240 x 25 mm	55,83 €/m
	DZ3029	Tube rectangle 44 x 25 mm avec alveois	6 m	44 x 25 mm	10,67 €/m
	DZ1078	Tube rectangle renforcé 80 x 25 mm avec alveois	6 m	80 x 25 mm	14,70 €/m
	DZ3089	Tube rectangle renforcé 120 x 25 mm avec alveois	6 m	120 x 25 mm	27,13 €/m
	DZ2036	Profilé porte-tôle CTI	6 m	25 x 24 mm	18,50 €/m



	Référence	Description	Longueur	Taille	Prix H.T.
	DZ1022	Traverse 25mm	6 m	94 x 49 mm	52,61 €/m
	DZ1023	Traverse haute et basse 25mm	6 m	94 x 49 mm	57,11 €/m
	DZ1024	Montant vertical 25mm	6 m	74 x 61 mm	47,46 €/m
	DZ1141	Traverse intermédiaire 25mm	6 m	94 x 38 mm	33,08 €/m
	DZ1142	Cache rainure	6 m	25 x 20 mm	10,20 €/m
	DZ1143	Clip de fermeture	6 m	55 x 23,4 mm	11,16 €/m
	DZ1144	Profil de battue	6 m	65 x 64,4 mm	18,71 €/m
	EMA1143	Embout aluminium pour DZ1143		94,95 x 61 mm	8,50 €/m
	EMA1144DP	Embout plat aluminium DZ1144 Droit		135,95 x 68 mm	16,27 €/m
	EMA1144GP	Embout plat aluminium DZ1144 Gauche		135,95 x 68 mm	16,27 €/m

	Référence	Description	Longueur	Taille	Prix H.T.
	ACPO1001	Serrure à encastrer pêne rentrant			54,38 €/m
	ACPO1002	Gâche tête GK2			9,76 €/m
	ACPO1004	Cylindre double (35+35) laiton nickelé varié			21,44 €/m
	ACPO1010	Sabot tourniquet ép. 30 à 85, hauteur 40m			42,28 €/m
	ACPO1007	Gond orientable L D12 axe 60-85, hauteur 25			43,51 €/m
	ACPO1048	Oreille à visser droite			24,76 €/m
	ACPO1049	Oreille à visser gauche			24,76 €/m
	ACPO1051	Rosace de cylindre zamak brut			6,80 €/m
	ACPO1052	Poignée brut bequille MARINEA épaisseur 30 à 60 mm			19,83 €/m
	JO008	Joint de butée	200 m		1,40 €/m



CO604020



DZ1143



DZ1024



DZ1023



EMA1143

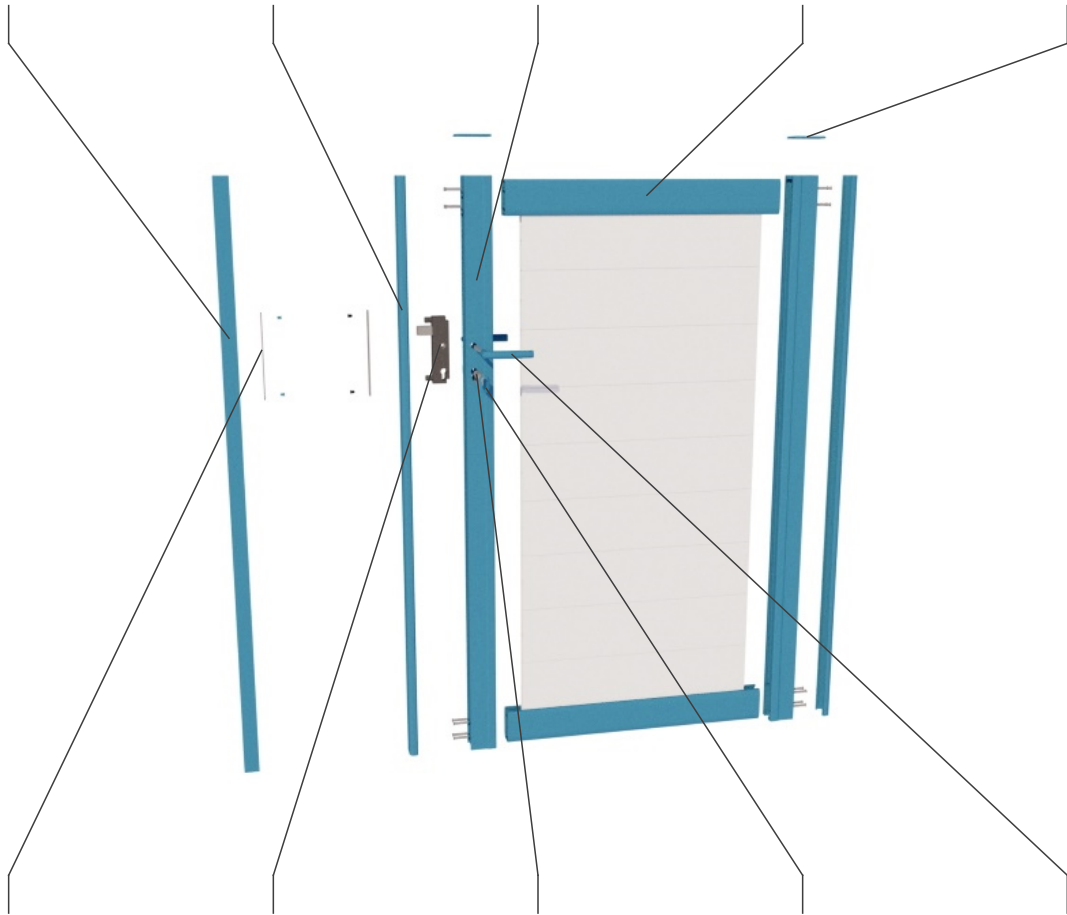

ACPO1002



ACPO1001



ACPO1004



















ACPO1051





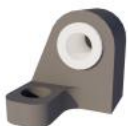





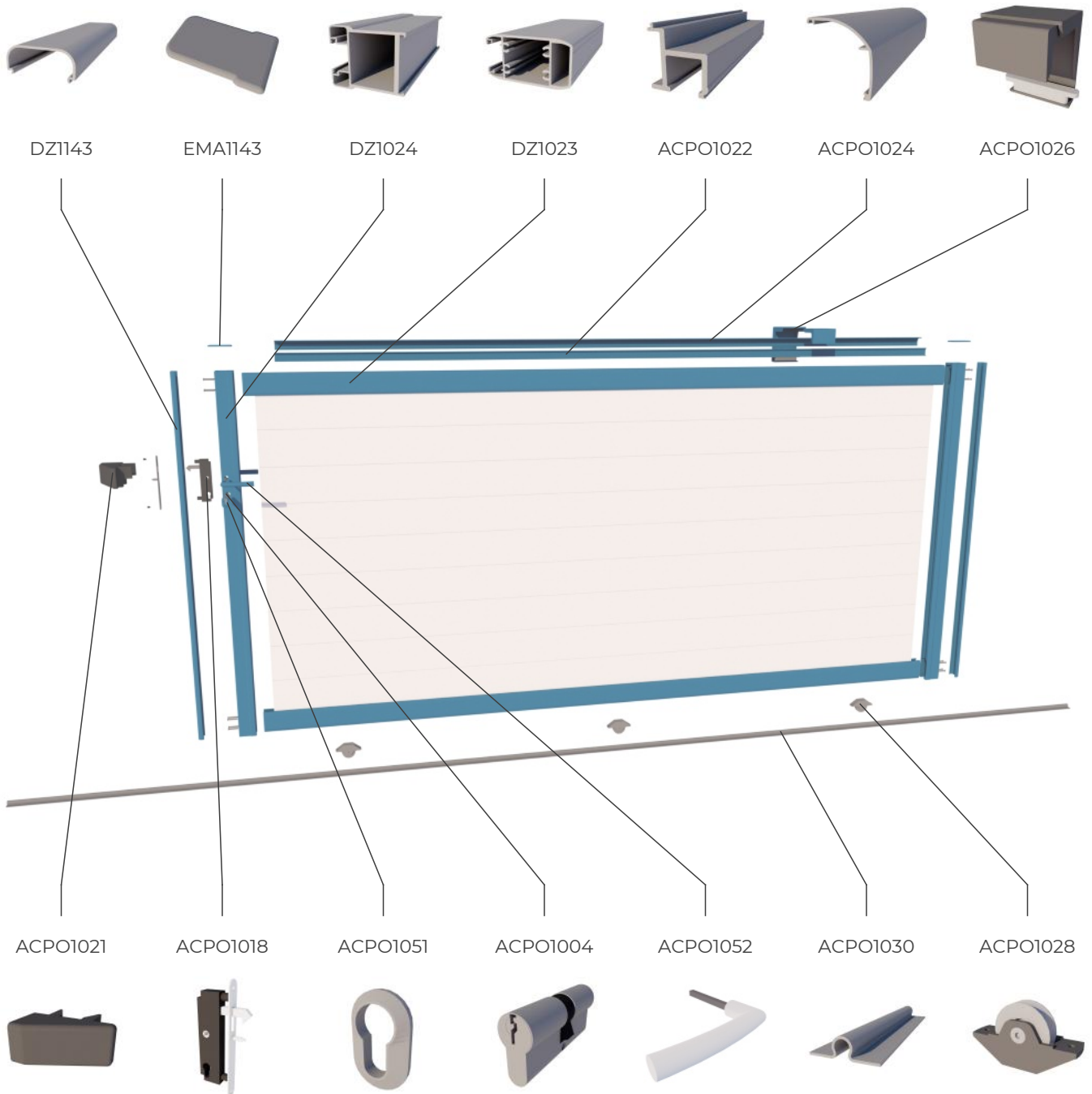

ACPO1052









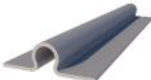

	Référence	Description	Longueur	Taille	Prix H.T.
	DZ1022	Traverse 25mm	6 m	94 x 49 mm	52,61 €/m
	DZ1023	Traverse haute et basse 25mm	6 m	94 x 49 mm	57,11 €/m
	DZ1024	Montant vertical 25mm	6 m	74 x 61 mm	47,46 €/m
	DZ1141	Traverse intermédiaire 25mm	6 m	94 x 38 mm	33,08 €/m
	DZ1142	Cache rainure	6 m	25 x 20 mm	10,20 €/m
	DZ1143	Clip de fermeture	6 m	55 x 23,4 mm	11,16 €/m
	EMA1143	Embout aluminium pour DZ1143		94,95 x 61 mm	8,50 €/m
	CO604020	Cornière inégale 60 x 40 x 2 mm	6 m	60 x 40 x 2 mm	9,20 €/m
	ACPO1001	Serrure à encastrer pêne rentrant			54,38 €/m
	ACPO1002	Gâche tête GK2			9,76 €/m

	Référence	Description	Longueur	Taille	Prix H.T.
	ACPO1004	Cylindre double (35+35) laiton nickelé varié			21,44 €/m
	ACPO1007	Gond orientable L D12 axe 60-85, hauteur 25			43,51 €/m
	ACPO1048	Oreille à visser droite			24,76 €/m
	ACPO1049	Oreille à visser gauche			24,76 €/m
	ACPO1051	Rosace de cylindre zamak brut			6,80 €/m
	ACPO1052	Poignée brut bequille MARINEA épaisseur 30 à 60 mm			19,83 €/m
	JO008	Joint de butée	200 m		1,40 €/m



	Référence	Description	Longueur	Taille	Prix H.T.
	DZ1022	Traverse 25mm	6 m	94 x 49 mm	52,61 €/m
	DZ1023	Traverse haute et basse 25mm	6 m	94 x 49 mm	57,11 €/m
	DZ1024	Montant vertical 25mm	6 m	74 x 61 mm	47,46 €/m
	DZ1141	Traverse intermédiaire 25mm	6 m	94 x 38 mm	33,08 €/m
	DZ1142	Cache rainure	6 m	25 x 20 mm	10,20 €/m
	DZ1143	Clip de fermeture	6 m	55 x 23,4 mm	11,16 €/m
	EMA1143	Embout aluminium pour DZ1143		94,95 x 61 mm	8,50 €/m
	ACPO1022	Rail supérieur seul, alu brut (longueur 5,6 m)			143,13 €/m
	ACPO1024	Profilé de clippage alu brut (longueur 5,6 m)			100,52 €/m
	ACPO1044	Embout de rail de guidage noir			17,08 €/m

	Référence	Description	Longueur	Taille	Prix H.T.
	ACPO1004	Cylindre double (35+35) laiton nickelé varié			21,44 €/m
	ACPO1018	Serrure à encastrer pêne levant			72,51 €/m
	ACPO1021	Gâche complète zamak noir, coulissant			109,01 €/m
	ACPO1030	Rail inférieur, acier galvanisé (longueur 3,5 m)			61,69 €/m
	ACPO1026	Platine de guidage petit modèle			100,98 €/m
	ACPO1028	Galet acier diam 60 encastré			47,50 €/m
	ACPO1032	Butée portail coulissant réglable			36,67 €/m
	ACPO1051	Rosace de cylindre zamak brut			6,80 €/m
	ACPO1052	Poignée brut bequille MARINEA épaisseur 30 à 60 mm			19,83 €/m

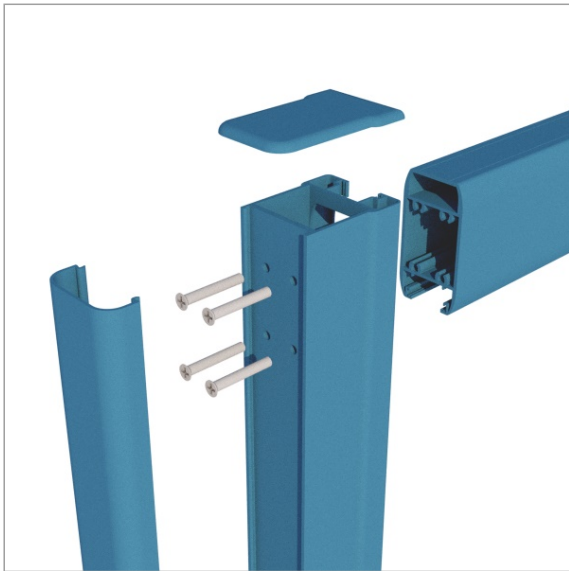

Montage en tenon-mortaise

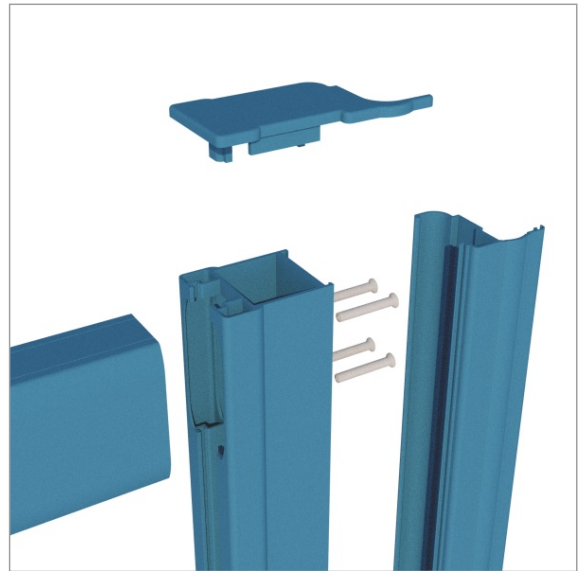

Montage en tenon-mortaise

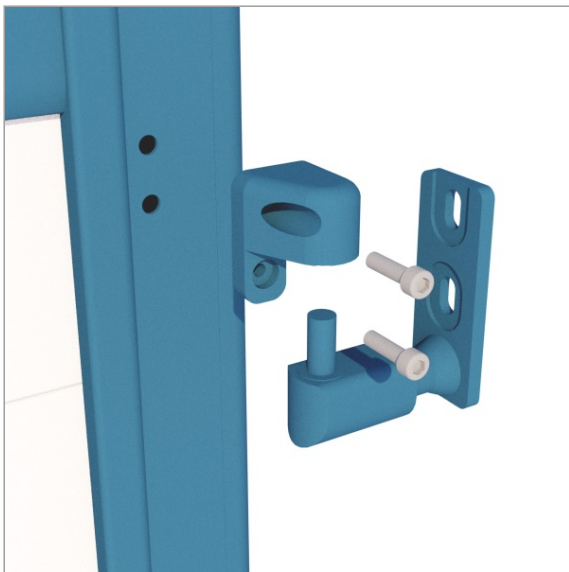

Fixation du gond



Fixation de la serrure

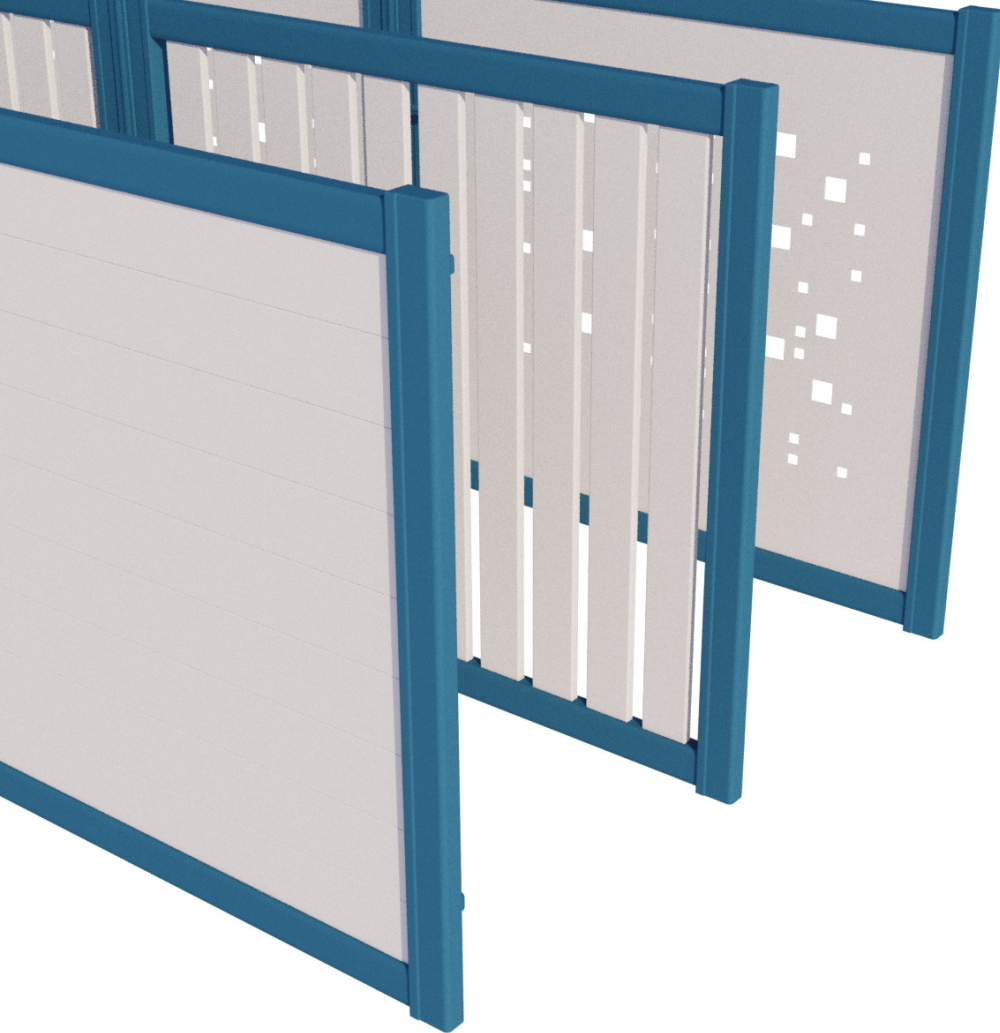

DZ Aluminium

Adresse : 4 rue de l'industrie
67118 Geispolsheim

Nous contacter

Téléphone : +33 (0)3 88 30 68 85

Mail : contact@dzaluminium.fr

Site web : www.dz-aluminium.fr